

ONE NAPKIN + A FEW FOLDS = LOTS OF CHARM

Presented by Alene Showers & Ariel Cooper
October 2001

LEADER'S GUIDE

Materials for Leaders

- Survey
- Outline of lesson
- Napkin folding booklet
- Napkin ring patterns and direction sheets
- Evaluation form
- Cloth napkins & paper napkins
- Small vases, wine & water glasses, napkin rings
- Assortment of "collectibles" for decorating
- Table cloth (bring one if one is not available at the meeting room)
- One or two dinner plates (paper will suffice)

Materials for Participants

- Survey
- Napkin folding booklet
- Napkin ring direction sheets
- Evaluation form

To prepare for the lesson, practice all of the folding directions in the booklet, cut out and construct several of the napkin rings from the direction sheet, and collect the items you will use to demonstrate "decorating tips." Arrange to have a tablecloth and cloth dinner napkins available. Bring in paper napkins, if they are not available also. Most of the folds are easier to perform if you have stiff napkins. Check out your napkins to see which ones are best for each type of fold. Certain folds require napkins that are perfectly square; have some of this type available, if possible. Some folds work with paper napkins; some do not. Note: the tablecloth is a luxury, not a necessity, as are the dinner plates. They do help to demonstrate the effectiveness of your decorations, however.

Adapted from a lesson presented at National FCE in Providence, RI

By...

Carolyn Rupp and Dr. Jacqueline Maly

July 2001

LESSON OUTLINE

The objectives of this lesson are

- Participants will discover the collectibles they have to use for table decorations
- Participants will practice several types of napkin folds
- Participants will learn about the use of napkin rings for decorating

Activity #1

Survey: Give participants the *survey sheet and ask them to list the sets of small collectibles they have in their home. Ask them to list the tablecloths that they have also. (about 2 minutes) (*survey sheets in back of booklet)

Ask several participants to volunteer to share their list of collectibles. (about 5 minutes) Then talk about how these collectibles can be used to decorate the table for conversation as well as beauty. (about 3 minutes)

Activity #2

Ask how many participants have cloth napkins tucked away in drawers and laundry baskets. Ask how many get the napkins out and use them? How often? Demonstrate each of the folding techniques listed in the booklet, letting the participants practice each one before proceeding to the next one. (Practice only as many as you have time for.) (about 25 minutes)

Activity #3

Show the napkin rings that you have brought in. Talk about how they help to carry the decorating theme. Show the "bone-based" napkin rings that you have made. Talk about the different variations of this basic pattern. (about 5 minutes)

Summary: Summarize the lesson and repeat the objectives. (about 2 minute)

Evaluation

Hand out the evaluations. Ask each participant to fill one out and turn it in.

Adapted from a National FCE lesson by Alene Showers for Oregon FCE, Oct. 2001

ONE NAPKIN + A FEW FOLDS = LOTS OF CHARM

List the sets of items you have in your home that you can use for table decorations.

1. _____
2. _____
3. _____
4. _____

List the table cloths and napkins that you have.

1. _____
2. _____
3. _____
4. _____

Keep this list handy as a reminder that it doesn't cost much to set an attractive table.

Developed by Alene Showers for Family and Community Education, October 2001

RESOURCE LIST for *One Napkin + a Few Folds... lesson*

PRESENTATION BOOKLET

One Napkin + a Few Folds = Lots of Charm, presented by Carolyn Rupp and Dr. Jacqueline Maly at the 2001 National Conference of FCE, July 19-22.

INTERNET SITES

<http://geocities.com/robbiehaf/robbiesKitchen/napkinempire.jpg>

<http://www.geocities.com/robbiehaf/robbiesKitchen/napkinfleur.JPG>

<http://geocities.com/robbiehaf/robbiesKitchen/napkincandlefan.jpg>

<http://geocities.com/robbiehaf/robbiesKitchen/napkinorientalfan.JPG>

One Napkin + A Few Folds = Lots of Charm lesson developed for Family Community Education, October 2001

SOME NAPKIN FOLDING TECHNIQUES

THE SWIRL

1. Lay the napkin out flat.
2. Starting with one of the corners, roll the napkin up.
3. Bend the napkin in the middle and place it in a glass.

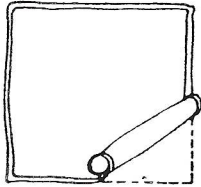

1



2

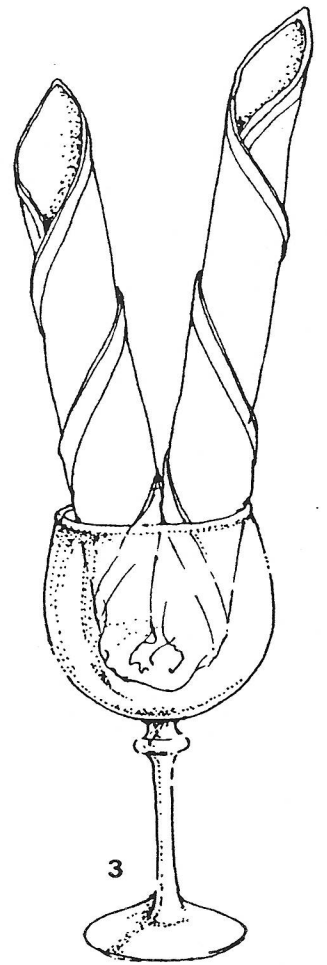

3

Roll several colored &/or patterned napkins in a swirl, fold as indicated and put them in a large goblet or vase as a centerpiece.

SIMPLICITY

1. Fold the napkin into quarters.
2. Turn up the bottom corner.
3. Fold into thirds.
4. Turn the napkin over and lay it flat.

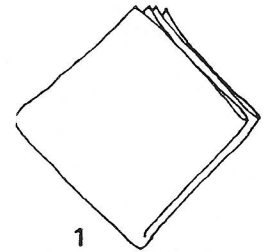

1

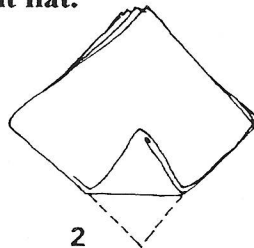

2



3



4

*One Napkin + a Few Folds = Lots of Charm, Developed for Family Community Education
October 2001 (adapted from a lesson presented at National, July 2001)*

THE AMERICANIA

1. Fold the napkin into quarters.
2. Fold the bottom and side Corners to the center.
3. Fold into thirds.
4. Slip through a napkin ring.

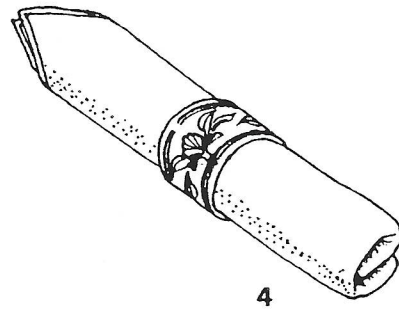
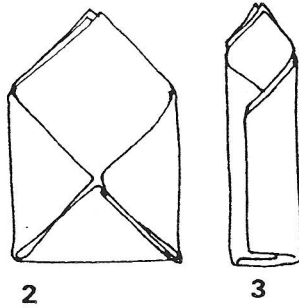
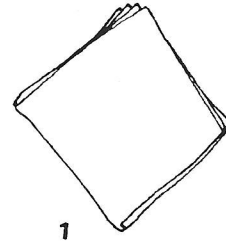

THE CONE

1. Fold the napkin in half.
2. Roll into a cone.
3. Fold the bottom point up.
4. Fold the bottom of the cone up to form a cuff, and stand the napkin upright.

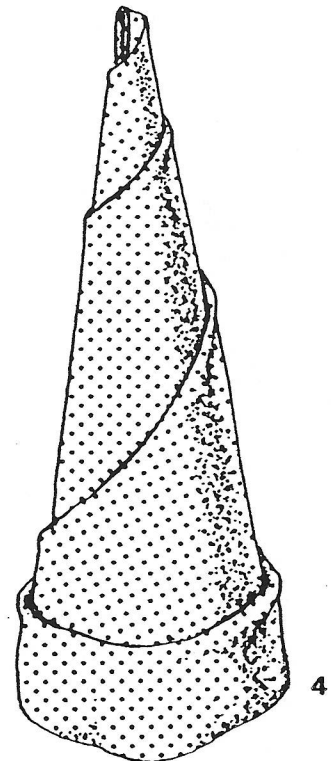
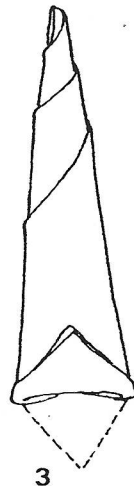
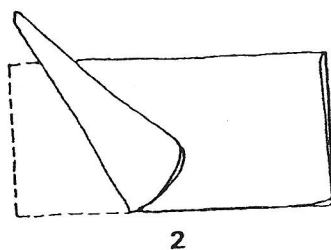
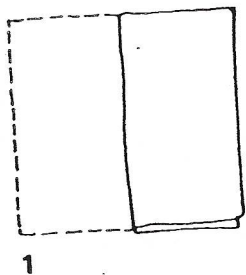

Can be made with large paper napkins.

BUFFET NAPKIN

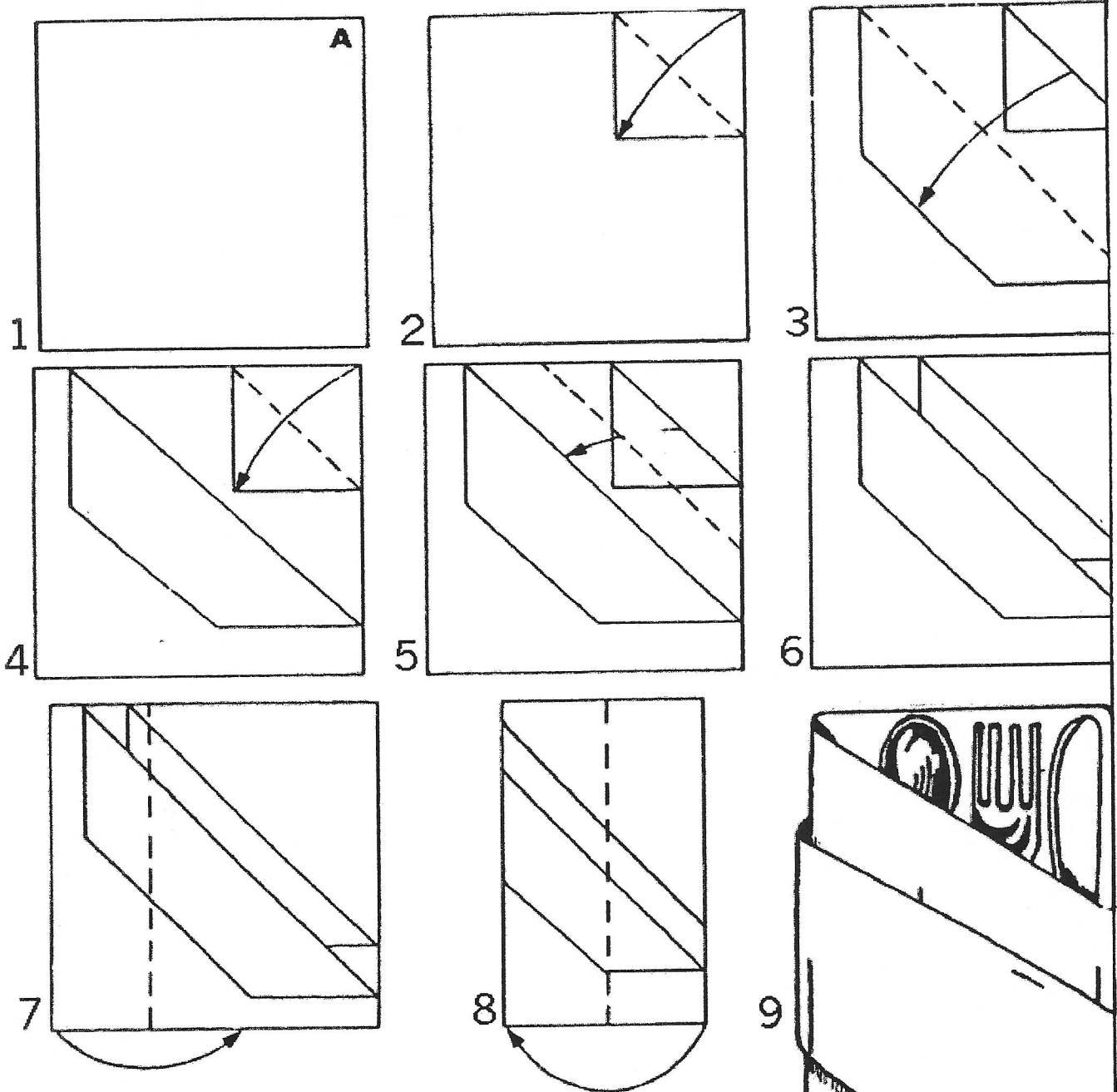

1. Fold napkin in fourths, ensuring that the loose edges are at point A.
2. Fold down the top flap as indicated.
3. Fold along dotted lines.
4. Fold down second flap.
5. Fold second flap along dotted line.
6. Tuck second flap under first fold.
7. Fold napkin along dotted line, putting fold underneath.
8. Fold napkin along dotted Line.
9. Finished fold with silverware inside fold.

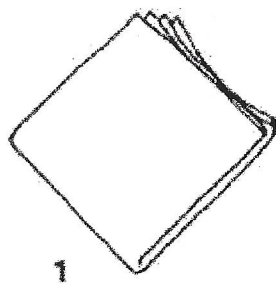

1

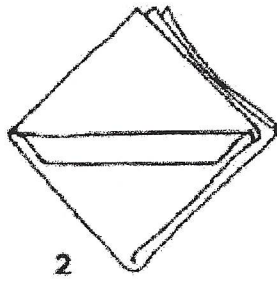

2

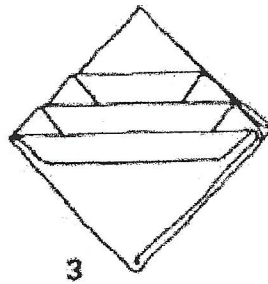

3

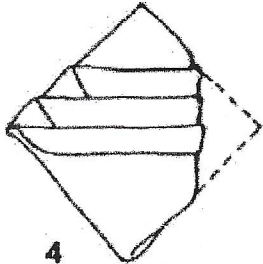

4



THE EMPIRE

1. Fold the napkin into quarters with the free corners at the top.
2. Fold the top flap down in quarters.
3. Fold down thesecond and third flaps and tuck them behind the first to make 3 equal bands.
4. Fold back the sides and lay the napkin flat.

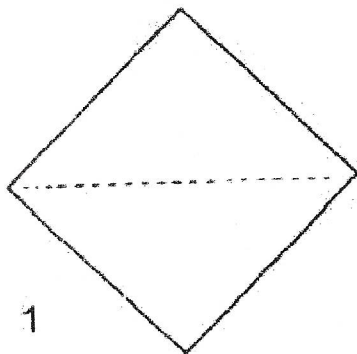

1

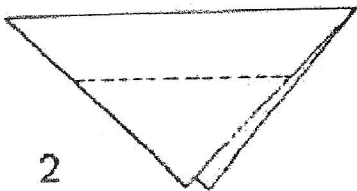

2



3

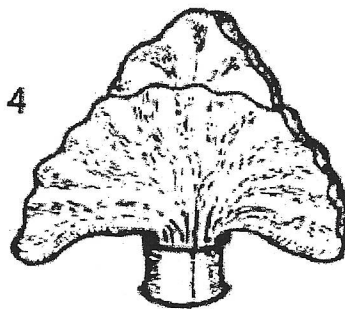

4

THE FLEUR-DE-LYS

1. Fold the napkin in half to form a triangle.
2. Fold the points to the rear along the dotted lines as shown.
3. Pleat the napkin right across from left to right.
4. Open out the pleats and arrange in a small glass or napkin ring.

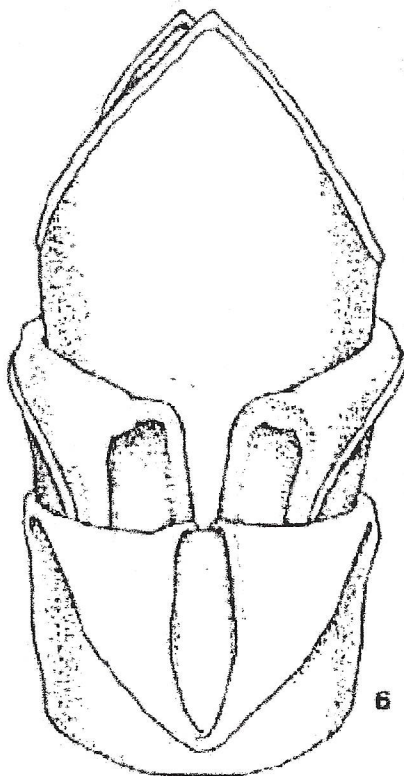
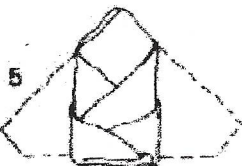
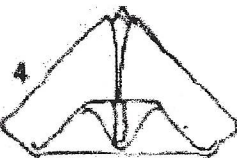
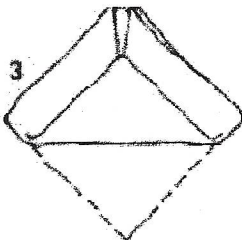
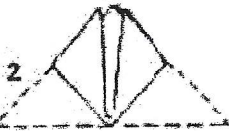
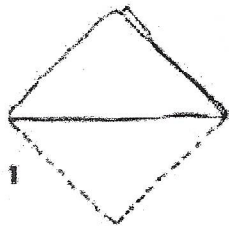

THE BISHOP'S HAT

1. Fold the napkin in half to form a triangle.
2. Fold the left and right corners up to meet at the top point, forming a diamond.
3. Fold the bottom corner up, leaving about 1 in. at the top.
4. Fold the corner back to the bottom edge.
5. Turn the napkin over and bring each of the sides back, tucking one into the other.
6. Stand the napkin upright and tuck each of the flaps into the cuff.

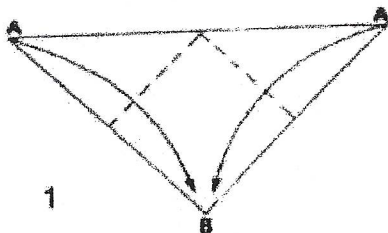

1

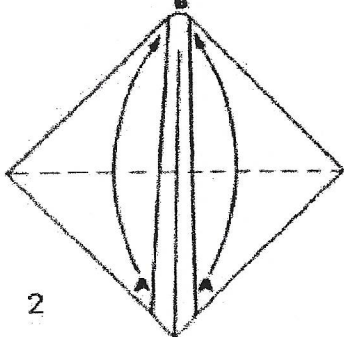

2

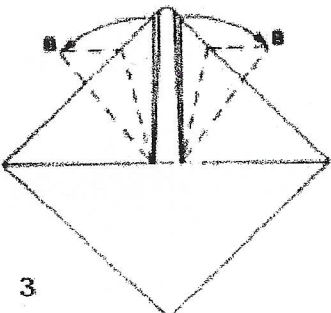

3

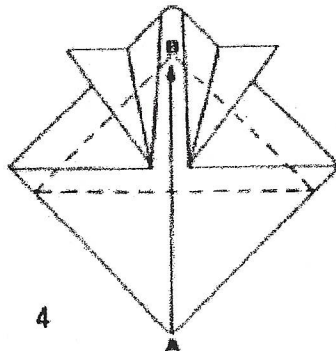

4

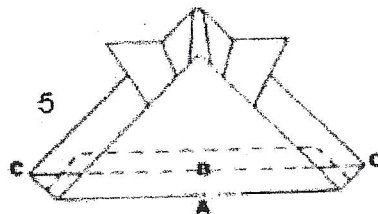

5

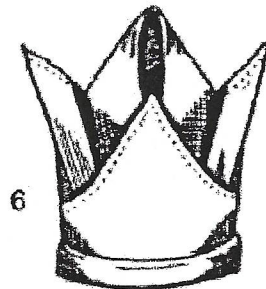

6

THE VIKING HAT

1. Fold the napkin in half diagonally then fold corners A to B.
2. Fold 2 flaps marked A up to B.
3. Fold the two flaps marked A out to the dotted lines at B.
4. Fold A to B ensuring that the fold falls along the bottom dotted line.
5. Fold bottom edge A along dotted line B, then tuck ends marked C around the back to make napkin stand up.
6. Finished fold.

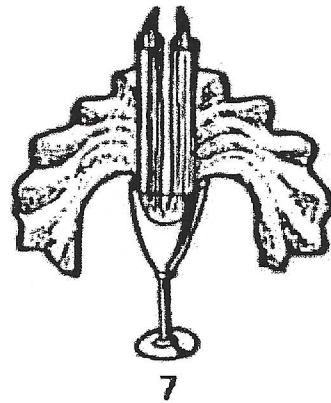
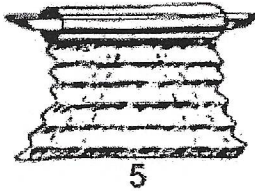
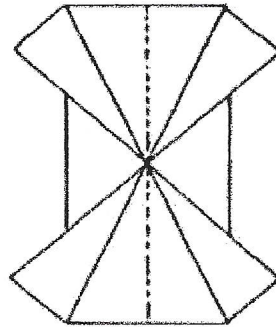
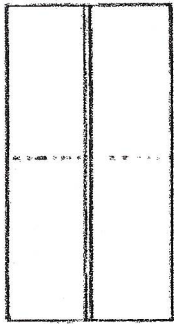
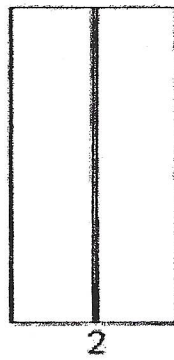
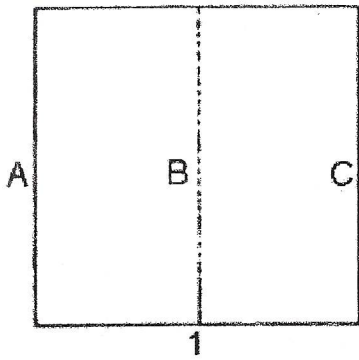

THE CANDLE FAN

1. Lay the napkin flat.
2. Fold edges A and C to center line B.
3. Crease as shown by dotted line.
4. Fold out the 4 corners diagonally.
5. Tightly roll from the top to the center line. Pleat the remainder.
6. Fold in half as shown.
7. Arrange in glass.

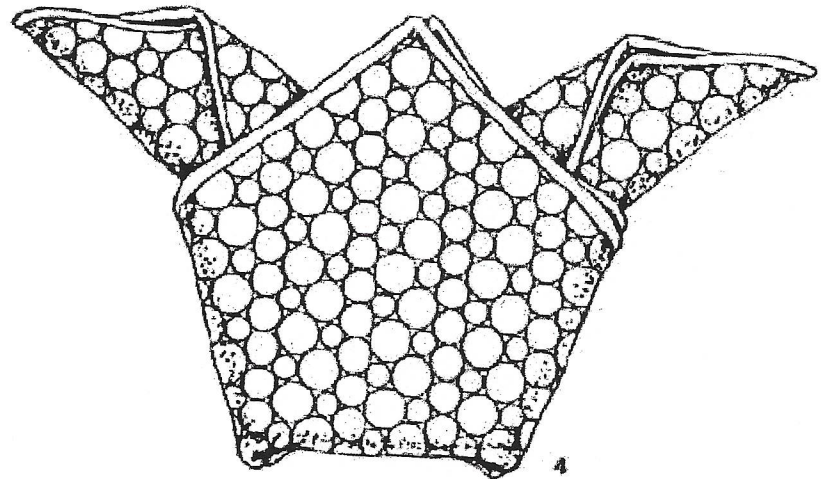

THE ASCOT TIE

1. Fold the napkin in half diagonally.
2. Fold the bottom edge up by one quarter twice.
3. Fold the sides over.
4. Turn the napkin over and lay it flat.

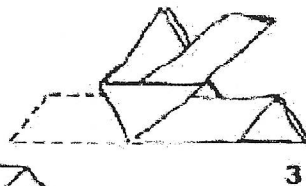
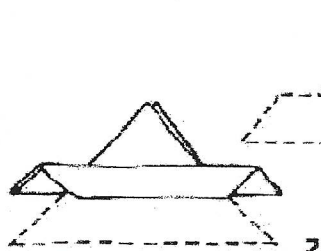
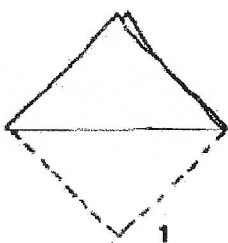

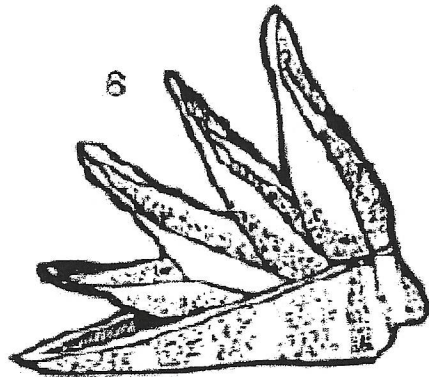
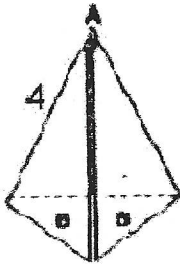
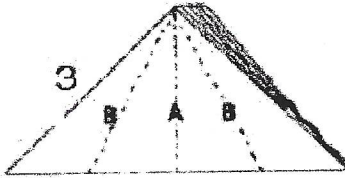
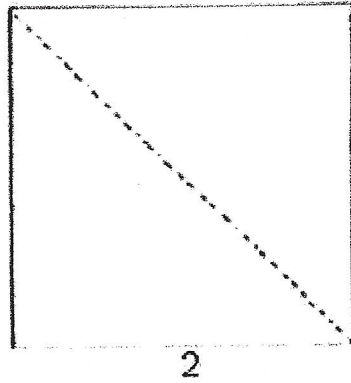
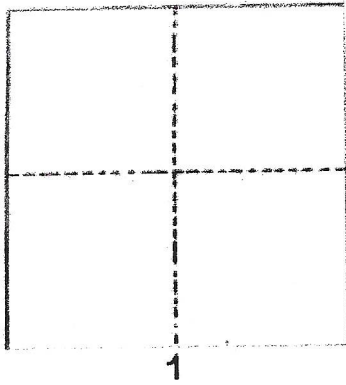

THE COCK'S COMB

1. Fold as indicated on dotted line.
2. Fold diagonally.
3. Turn napkin so that the points are away from you. Fold sides B along dotted line to meet at center A.
4. Turn points of B under.
5. Fold along the center line A and stand the napkin with fold uppermost.
6. Pull up the four pleats and arrange to produce finished fold.

Setting an attractive table is not a lost art. We just need to remind ourselves to do it. It costs nothing except a little effort.

Linens are made to be used. You may not have any napkin rings, but everyone has items around the house to use as napkin accents or ties. Instead of buying flowers for a centerpiece, display some of your 'collectibles.'

Your efforts will stimulate conversation and provide interesting memories.

So take those napkins out of the drawers, gather some of your favorite things for centerpieces, and surprise your friends with a nicely decorated table.

Carolyn Rupp and Dr. Jacqueline Maly

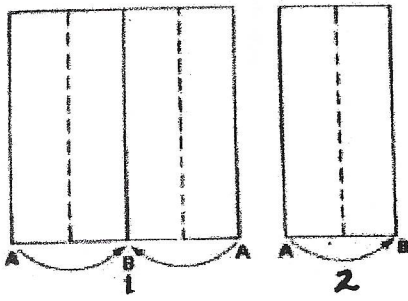

THE ORIENTAL FAN

1. Lay the napkin flat and fold along the dotted lines, bringing points A to B.

2. Fold A to B. This will give a W effect if viewed from the end of the napkin.

3. Pleat the napkin making 2 in. pleats.

4. Hold the napkin at the bottom bringing points A and B together.

5. Open the pleats and pull down one side.

6. Turn the napkin around and repeat stage 5.

7. Open the pleats into a fan shape and stand on table.

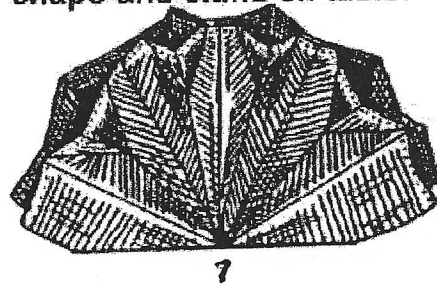
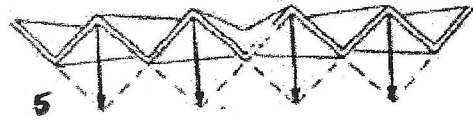
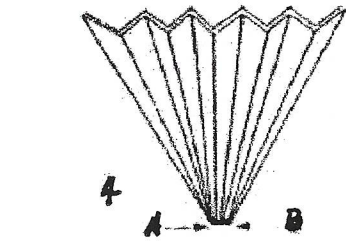

AFTERNOON TEA

1. Fold napkin into quarters.

2. Turn up the bottom corner.

3. Fold into thirds.

4. Turn the napkin over and lay flat.

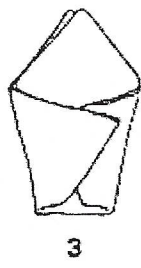
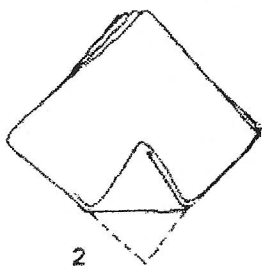
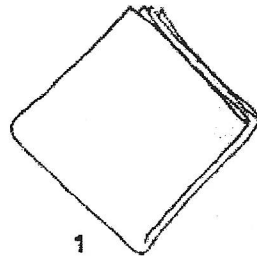

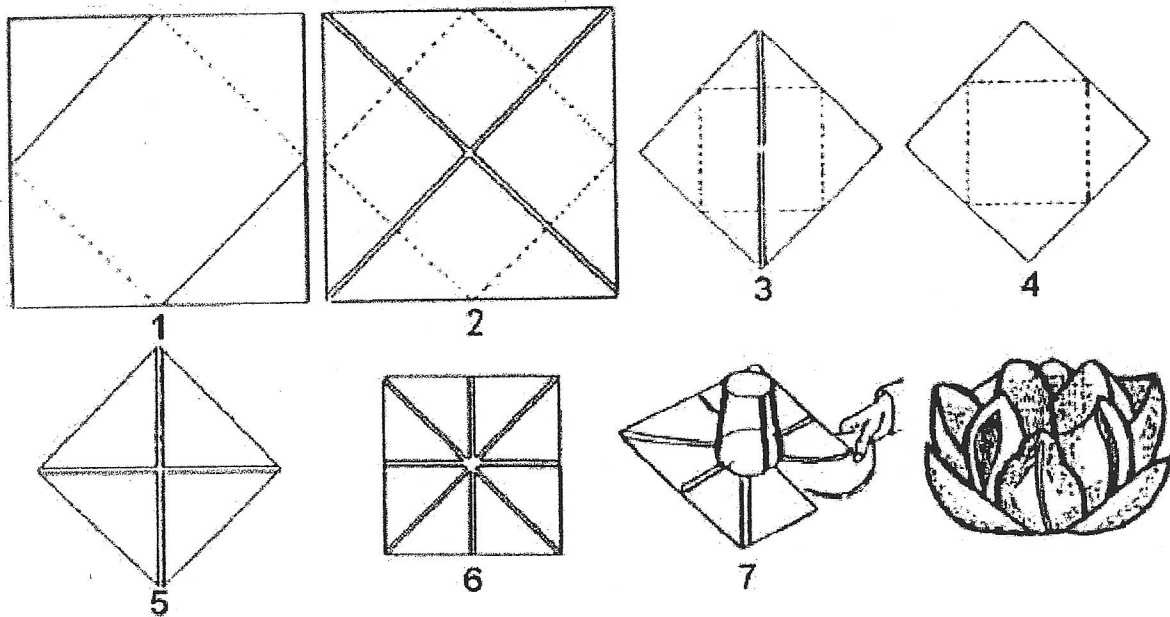

THE ROSE

1. Lay napkin flat and fold along dotted lines.
2. Turn through 45 degree folds and fold along the dotted lines.
3. Turn again and fold on dotted lines.
4. Turn napkin over and fold on dotted lines.
5. Napkin after stage 4.
6. Place a cup over the points in the center.
7. Pull each of the 12 points gently away from underneath, taking opposite corners in turn.

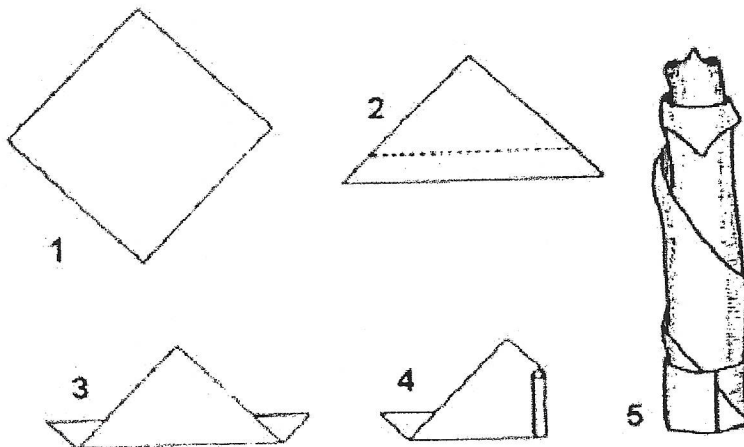

THE CANDLE

1. Lay napkin out as diamond.
2. Fold as indicated on the dotted line.
3. Turn so that the fold is away from you.
4. Roll the napkin inwards from the right, tucking in the end to fasten.
5. Finished fold.

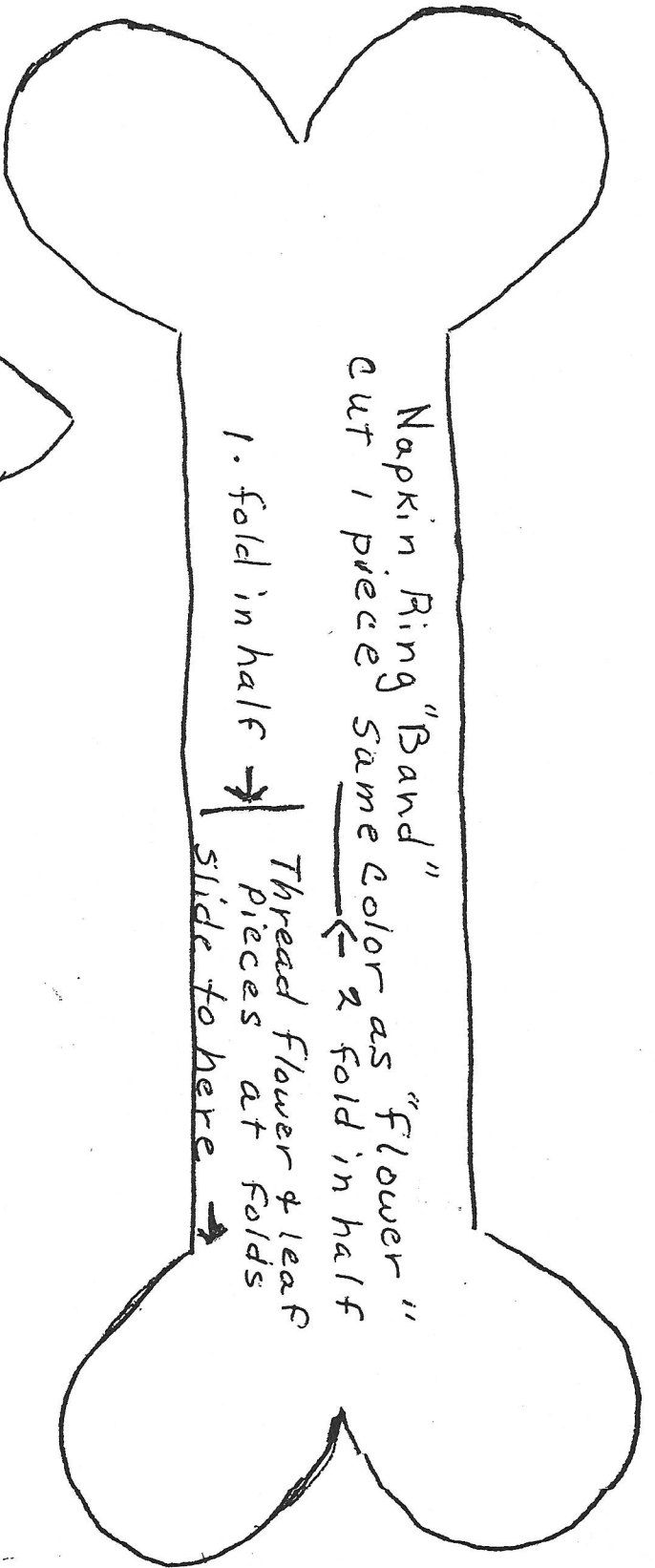

Napkin Ring "Band"
 "Flower"
 cut 1 piece same color as "Flower"
 ← 2 fold in half

1. fold in half →
 Thread flower & leaf pieces at folds
 slide to here →

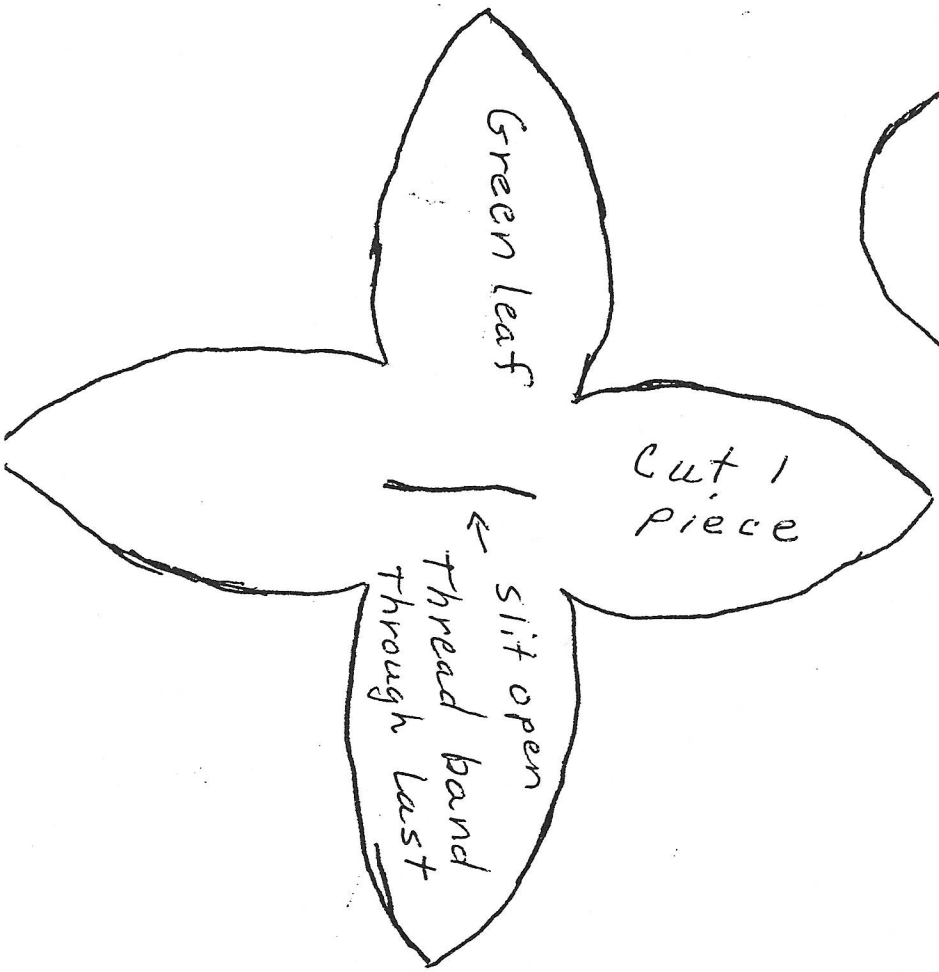

Cut 1 piece

← slit open
 thread band
 through last

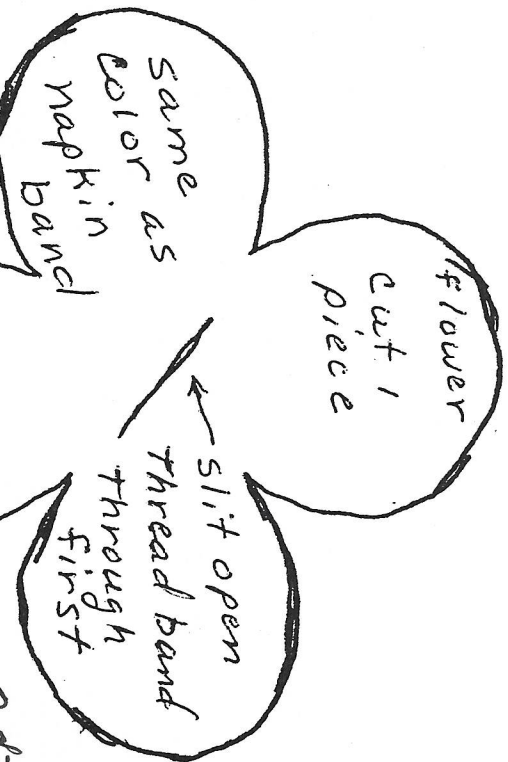

flower
 cut 1 piece

same as
 color as
 napkin
 band

← slit open
 thread band
 through first

Make 2 of these

